

H7584 Parts Breakdown and List

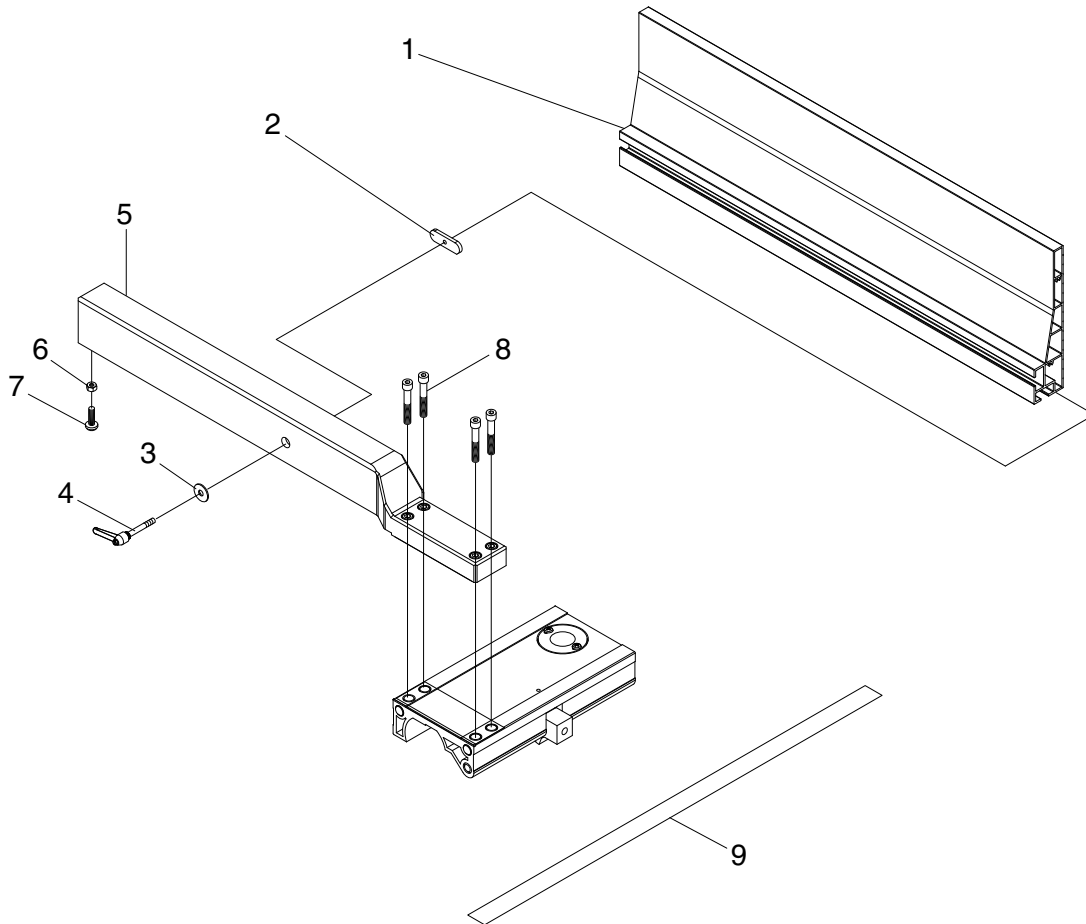

REF	PART #	DESCRIPTION
1	PH7584001	RESAW FENCE (AL) 505mm
2	PH7528002	MOVING PLATE
3	PW01M	FLAT WASHER 8MM
4	PH7528004	ADJUSTMENT HANDLE M8 X 44
5	PH7587007	FENCE SUPPORT TUBE 505MM
6	PN01M	HEX NUT M6-1
7	PH7587010	ADJUST SCREW
8	PSB07M	CAP SCREW M6-1 X 30
9	PH7587021	SCALE

COPYRIGHT © JUNE, 2005 BY GRIZZLY INDUSTRIAL, INC. REVISED SEPTEMBER, 2005.
**WARNING: NO PORTION OF THIS MANUAL MAY BE REPRODUCED IN ANY SHAPE
OR FORM WITHOUT THE WRITTEN APPROVAL OF GRIZZLY INDUSTRIAL, INC.**
#TR7286 PRINTED IN TAIWAN

For replacement parts, call 1-800-523-4777. For help, call Technical Support at 1-570-546-9663 or email tech-support@grizzly.com.